

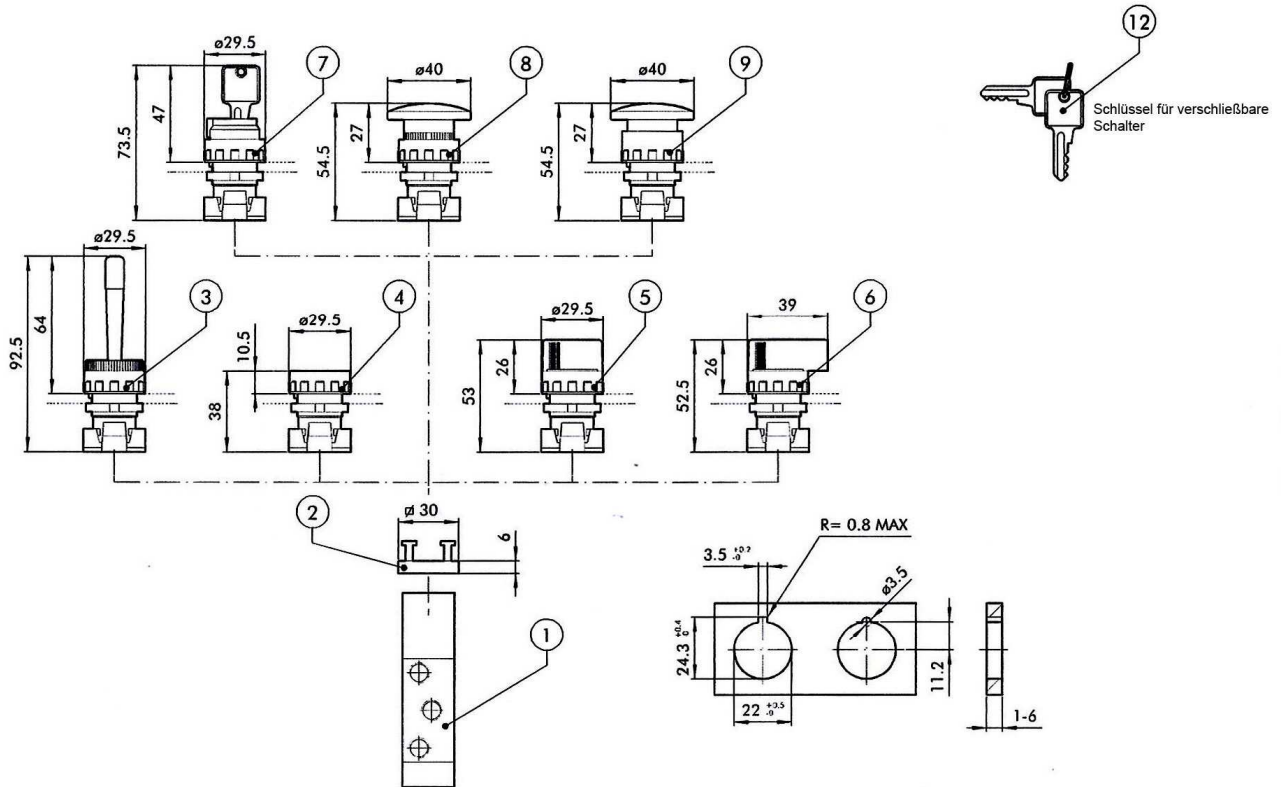











Passend für die Wegeventile:
 Artikel Nr. 512.111 bis 512.704
 Artikel Nr. 515.201 bis 515.701
 Artikel Nr. 515.211 bis 515.711

Ident Nr. 106397 bis 106416
 Ident Nr. 106417 bis 106428
 Ident Nr. 106429 bis 106440

BESTELNUMMERN

| Symbol | Ident Nr. | Ziffer | Artikel Nr. | Beschreibung | Gewicht [g] |
|---|-----------|--------|-------------|--|-------------|
|  | 106441 | ① | 515.101 | Stößelventil 3/2 NC 1/8" | 124 |
|  | 106442 | ① | 515.111 | Stößelventil 5/2 monostabil 1/8" | 150 |
| | 106443 | ② | A2V | Adapter für bis zu 2 Ventile, Dicke 6.8 mm | 5 |
|  | 106445 | ③ | HH-M | Horizontal schwenkender roter Handhebel | 25 |
|  | 106444 | ④ | DK-M | Drucktaster mit roter und schwarzer Scheibe | 15 |
|  | 106446 | ⑤ | KDH-2M | Drehhebel, schwarz, 2 Stellungen - monostabil | 20 |
| | 106447 | ⑤ | KDH-2B | Drehhebel, schwarz, 2 Stellungen - bistabil | 20 |
|  | 106448 | ⑤ | KDH-3M | Drehhebel, schwarz, 3 Stellungen - monostabil | 20 |
| | 106449 | ⑤ | KDH-3B | Drehhebel, schwarz, 3 Stellungen - bistabil | 20 |
|  | 106450 | ⑥ | LDH-2M | Langer Drehhebel, schwarz, 2 Stellungen - monostabil | 26 |
| | 106451 | ⑥ | LDH-2B | Langer Drehhebel, schwarz, 2 Stellungen - bistabil | 26 |
|  | 106452 | ⑥ | LDH-3M | Langer Drehhebel, schwarz, 3 Stellungen - monostabil | 26 |
| | 106453 | ⑥ | LDH-3B | Langer Drehhebel, schwarz, 3 Stellungen - bistabil | 26 |
|  | 106454 | ⑦ | V2SS-JS | Verschließbarer 2 Stellungsschalter mit Schlüsselabzug in jeder Stellung | 50 |
| | 106455 | ⑦ | V2SS-GS | Verschließbarer 2 Stellungsschalter mit Schlüsselabzug in Grundstellung | 50 |
|  | 106456 | ⑧ | RPT-M | Roter Pilztaster monostabil Ø 40 | 27 |
| | | | | Schwarzer Pilztaster monostabil Ø 40 | 27 |
|  | 106457 | ⑨ | RPT-NR | Roter Pilztaster rastend Ø 40 | 29 |