

Material

Stahl verzinkt (DIN 2353)

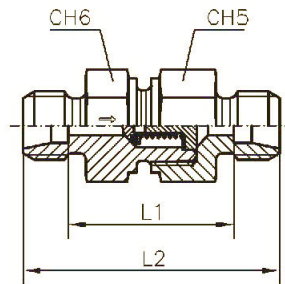
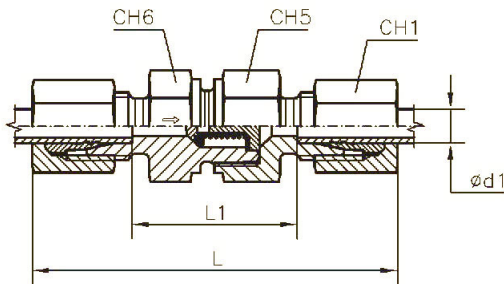

RSV6LST

Rückschlagventil, mit beidseitigem Rohranschluss, leichte Ausführung

Artikel Nr.	Typen Nr.	Rohr- Außen- \varnothing mm	L mm	L1 mm	L2 mm	CH1 mm	CH5 mm	CH6 mm	PN bar
159402	RSV6LST	6	58,0	29,0	43,0	14	17	17	250
159403	RSV8LST	8	59,0	30,0	44,0	17	19	19	250
159404	RSV10LST	10	69,5	40,5	54,5	19	24	22	250
159405	RSV12LST	12	72,5	43,5	57,5	22	30	27	250
159406	RSV15LST	15	77,5	47,5	61,5	27	32	27	250
159407	RSV18LST	18	83,5	51,5	66,5	32	36	36	160
159408	RSV22LST	22	93,5	61,5	76,5	36	46	41	160
159409	RSV28LST	28	102,5	69,5	94,5	41	55	50	100

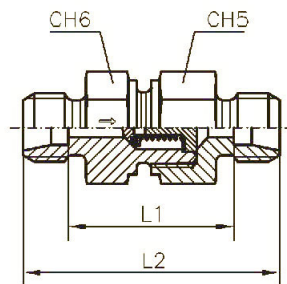
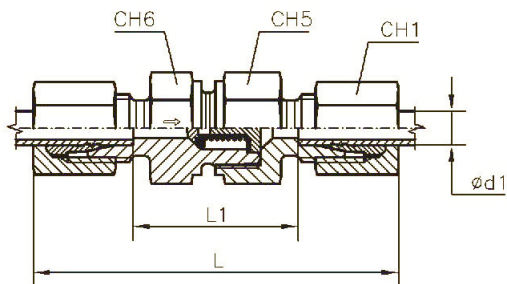

RSV6SST

Rückschlagventil, mit beidseitigem Rohranschluss, schwere Ausführung

Artikel Nr.	Typen Nr.	Rohr- Außen- \varnothing mm	L mm	L1 mm	L2 mm	CH1 mm	CH5 mm	CH6 mm	PN bar
159410	RSV6SST	6	63,5	34,5	48,5	17	19	19	400
159411	RSV8SST	8	63,5	34,5	48,5	19	19	19	400
159412	RSV10SST	10	72,5	40,5	55,5	22	24	22	400
159413	RSV12SST	12	74,5	42,5	57,5	24	27	24	400
159414	RSV14SST	14	82,5	47,5	63,5	27	32	27	400
159415	RSV16SST	16	86,5	50,5	67,5	30	36	32	400
159416	RSV20SST	20	97,5	54,5	75,5	36	46	41	400
159417	RSV25SST	25	106,5	58,5	82,5	46	50	46	250

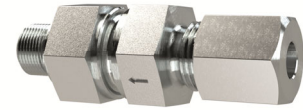
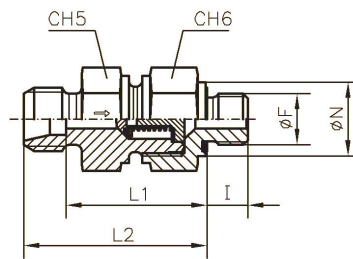
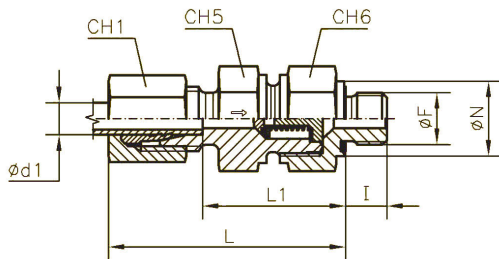

RSV618LST

Rückschlagventil, Durchflussrichtung Schneidring zum Gewinde, Außengewinde zylindrisch, leichte Ausführung

Artikel Nr.	Typen Nr.	Gewinde Ø F	Rohr- Außen-Ø mm	Ø N	I mm	L mm	L1 mm	L2 mm	CH1 mm	CH5 mm	CH6 mm	PN bar
159450	RSV618LST	G 1/8	6	14	8	41,0	26,5	41,5	14	17	17	250
159451	RSV814LST	G 1/4	8	19	12	43,0	28,5	47,5	17	19	19	250
159452	RSV1014LST	G 1/4	10	19	12	53,0	38,5	57,5	19	22	24	250
159453	RSV1238LST	G 3/8	12	22	12	55,0	40,5	59,5	22	27	30	250
159454	RSV1512LST	G 1/2	15	27	14	57,5	42,5	63,5	27	27	32	250
159455	RSV1812LST	G 1/2	18	27	14	64,0	48,0	69,5	32	36	36	160
159456	RSV2234LST	G 3/4	22	32	16	72,0	56,0	79,5	36	41	46	160
159457	RSV281LST	G 1	28	40	18	80,5	64,0	89,5	41	50	55	100

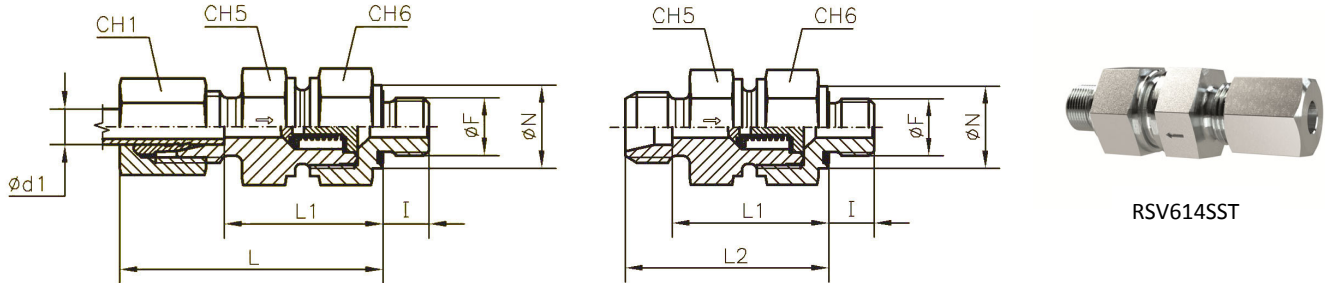

RSV614SST

Rückschlagventil, Durchflussrichtung Schneidring zum Gewinde, Außengewinde zylindrisch, schwere Ausführung

Artikel Nr.	Typen Nr.	Gewinde $\varnothing F$	Rohr- Außen- \varnothing mm	$\varnothing N$	I mm	L mm	L1 mm	L2 mm	CH1 mm	CH5 mm	CH6 mm	PN bar
159458	RSV614SST	G 1/4	6	19	12	46,0	31,5	50,5	17	19	19	400
159459	RSV814SST	G 1/4	8	19	12	46,0	31,5	50,5	19	19	19	400
159460	RSV1038SST	G 3/8	10	22	12	54,0	38,0	57,5	22	22	24	400
159461	RSV1238SST	G 3/8	12	22	12	57,0	41,0	60,5	24	24	27	400
159462	RSV1412SST	G 1/2	14	27	14	61,0	43,5	65,5	27	27	32	400
159463	RSV1612SST	G 1/2	16	27	14	64,0	46,0	68,5	30	32	36	400
159464	RSV2034SST	G 3/4	20	32	16	71,5	50,0	76,5	36	41	46	400
159465	RSV251SST	G 1	25	40	18	78,5	54,5	84,5	46	46	50	250

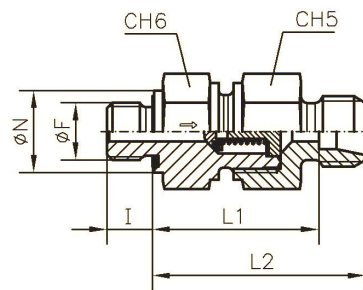
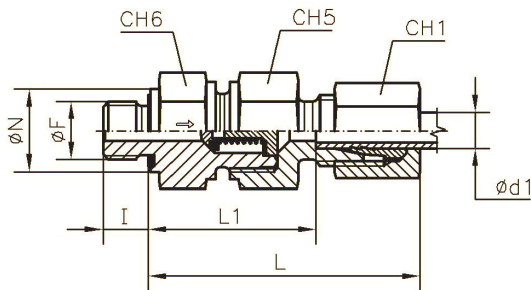

RSV186LST

Rückschlagventil, Durchflussrichtung Gewinde zum Schneidring, Außengewinde zylindrisch, leichte Ausführung

Artikel Nr.	Typen Nr.	Gewinde Ø F	Rohr- Außen-Ø mm	Ø N	I mm	L mm	L1 mm	L2 mm	CH1 mm	CH5 mm	CH6 mm	PN bar
159466	RSV186LST	G 1/8	6	14	8	42,5	28,0	43,0	14	17	17	250
159467	RSV148LST	G 1/4	8	19	12	44,5	30,0	49,0	17	19	19	250
159468	RSV1410LST	G 1/4	10	19	12	53,0	38,5	57,5	19	24	22	250
159469	RSV3812LST	G 3/8	12	22	12	57,0	42,5	61,5	22	30	27	250
159470	RSV1215LST	G 1/2	15	27	14	60,5	45,5	66,5	27	32	27	250
159471	RSV1218LST	G 1/2	18	27	14	66,0	50,0	71,5	32	36	36	160
159472	RSV3422LST	G 3/4	22	32	16	71,0	55,0	78,5	36	46	41	160
159473	RSV128LST	G 1	28	40	18	79,5	63,0	88,5	41	55	50	100

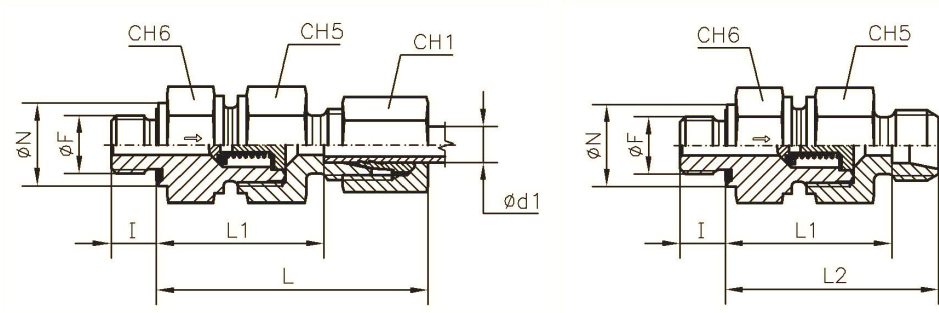

RSV146SST

Rückschlagventil, Durchflussrichtung Gewinde zum Schneidring, Außengewinde zylindrisch, schwere Ausführung

Artikel Nr.	Typen Nr.	Gewinde $\varnothing F$	Rohr- Außen- \varnothing mm	$\varnothing N$	I mm	L mm	L1 mm	L2 mm	CH1 mm	CH5 mm	CH6 mm	PN bar
159474	RSV146SST	G 1/4	6	19	12	46,0	31,5	50,5	17	19	19	400
159475	RSV148SST	G 1/4	8	19	12	46,0	31,5	50,5	19	19	19	400
159476	RSV3810SST	G 3/8	10	22	12	54,0	38,0	57,5	22	24	22	400
159477	RSV3812SST	G 3/8	12	22	12	57,0	41,0	60,5	24	27	24	400
159478	RSV1214SST	G 1/2	14	27	14	62,0	44,5	66,5	27	32	27	400
159479	RSV1216SST	G 1/2	16	27	14	66,0	48,0	70,5	30	36	32	400
159480	RSV3420SST	G 3/4	20	32	16	73,5	52,0	78,5	36	46	41	400
159481	RSV125SST	G 1	25	40	18	78,5	54,5	84,5	46	50	46	250