

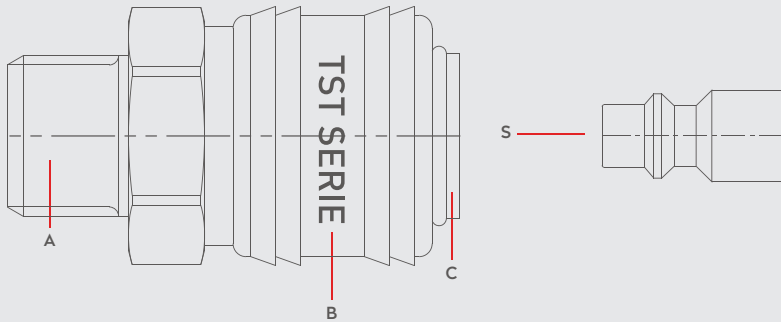



### Materials



### Material Code

- A = Brass
- B = Brass
- C = Brass
- S = Brass



0 - 35 bar  
(0-508 PSI)



-20° to + 100°C (NBR)  
-4° to + 212°F

### Shut Off Type

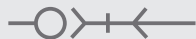



OM 250 - 00800  
OM 250 - 00500

### FLOW

550 lt/min

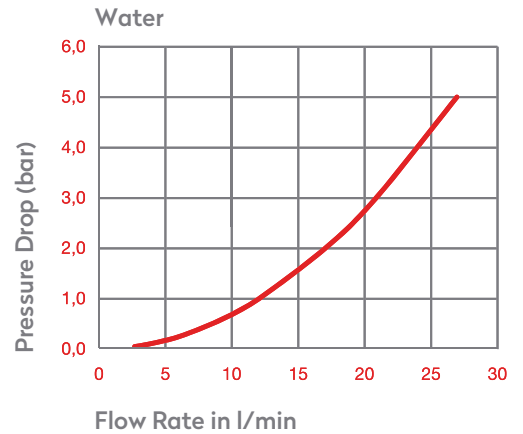
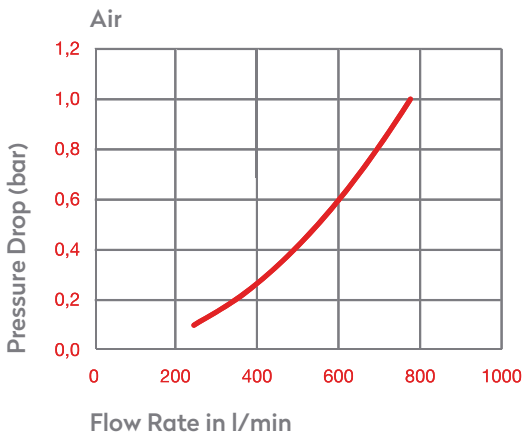
### DN 5.5 mm



### Options

NICKEL

SWING

2 STAGE

2 STAGE

B1 Serie

023S

023S.06

### Plug Profile Serie 024

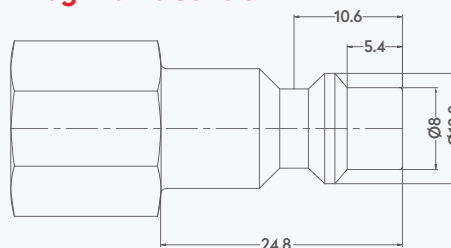

### Compatible with

TST SWING COUPLING	B1
TST	023
PARKER - RECTUS	23
CEJN	310
HANSEN	3000
RECTURS	24
ATLAS COPCO QIC	08



ISO 6150 - B - 12

US MIL STD. 4109 1/4"

## QUICK COUPLINGS SCHNELLKUPPLUNGEN

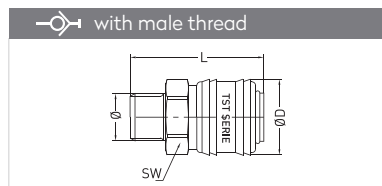

Connection	Part No.	SW	L	ØD
BSP 1/4"	024 EG 13	21	42,3	24,7
BSP 3/8"	024 EG 17	21	42,3	24,7
BSP 1/2"	024 EG 21	21	45,3	24,7

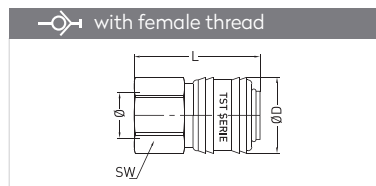

Connection	Part No.	SW	L	ØD
BSP 1/4"	024 DG 13	21	42,3	24,7
BSP 3/8"	024 DG 17	21	42,3	24,7
BSP 1/2"	024 DG 21	24	44,8	24,7

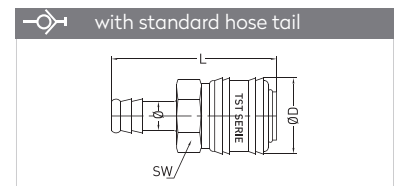

Connection	Part No.	SW	L	ØD
6 mm - 1/4"	024 HG 06	21	56,3	24,7
8 mm - 5/16"	024 HG 08	21	56,3	24,7
9 mm - 5/14"	024 HG 09	21	56,3	24,7
10 mm - 3/8"	024 HG 10	21	56,3	24,7
13 mm - 1/2"	024 HG 13	21	56,3	24,7

## PLUGS STECKNIPPEL

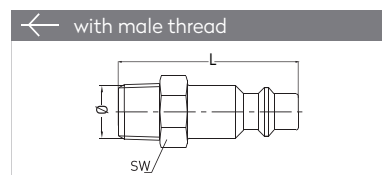

Connection	Part No.	SW	L
BSPT 1/8"	024 RU 10	13	38
BSPT 1/4"	024 RU 13	14	41,5
BSPT 3/8"	024 RU 17	17	42,5
BSPT 1/2"	024 RU 21	22	47,5
BSP 1/4"	024 EU 13	14	38,5
BSP 3/8"	024 EU 17	17	38,5

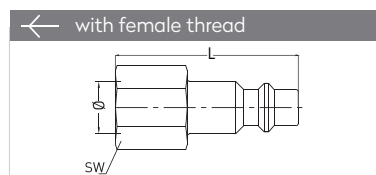

Connection	Part No.	SW	L
BSP 1/8"	024 DU 10	14	34
BSP 1/4"	024 DU 13	17	36
BSP 3/8"	024 DU 17	19	36
BSP 1/2"	024 DU 21	24	40

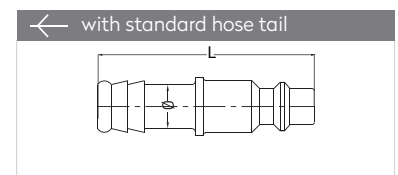

Connection	Part No.	L	ØD
6 mm - 1/4"	024 HU 06	50	12
8 mm - 5/16"	024 HU 08	50	12
9 mm - 5/14"	024 HU 09	50	12
10 mm - 3/8"	024 HU 10	50	12
13 mm - 1/2"	024 HU 13	50	15

## MULTIPLE OUTLET VERTEILER

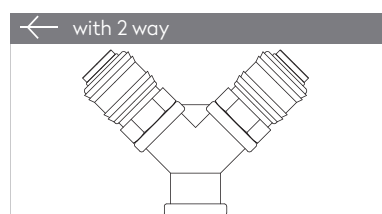

Connection	Part No.
BSP 3/8"	024 2G 17
BSP 1/2"	024 2G 21

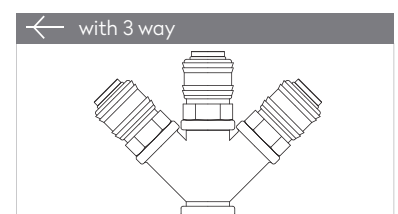

Connection	Part No.
BSP 3/8"	024 3G 17
BSP 1/2"	024 3G 21